

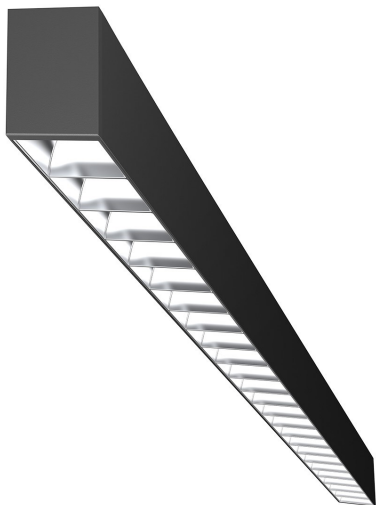

LUMTECH

Réglable linéaire 36W LED-IP20



LT-004219

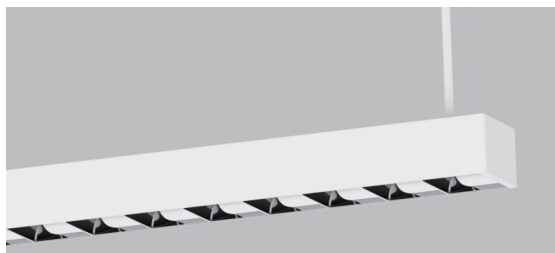

LT-004219-Kits-Susp-1

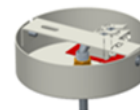
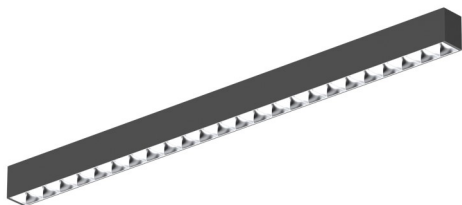

LT-004219-Kits-Susp-2

Données photométriques (4000k,65°) :

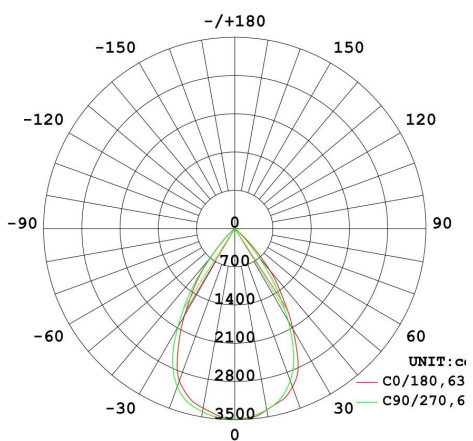

Courbe de distribution de la lumière [Unit : cd]

1m	1103,35391x	200.00cm
2m	275,7,884.71x	400.00cm
3m	122.5,393.21x	600.00cm
4m	68.92,221.21x	800.00cm
5m	44.11,141.51x	1000.00cm
6m	30.63,98.301x	1200.00cm
7m	22.50,72.221x	1400.00cm
8m	17.23,55.291x	1600.00cm
9m	13.61,43.691x	1800.00cm
10m	11.03,35.391x	2000.00cm

Courbe de Lux distance



LUMTECH

Régllette linéaire 36W LED-IP20

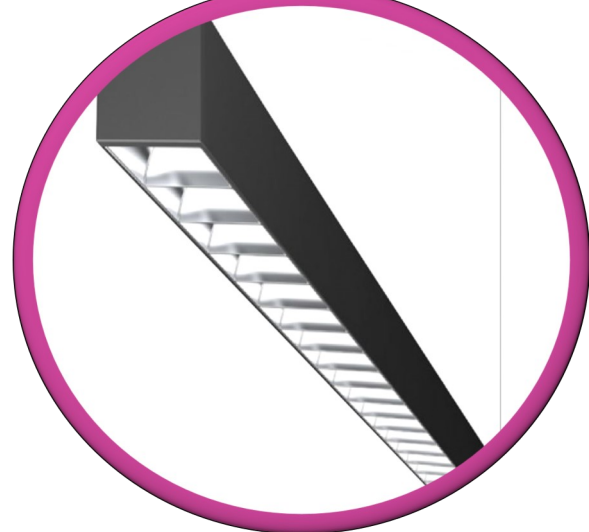

Dimensions :

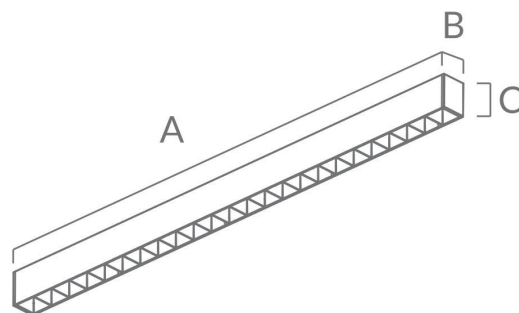

1212x57x76

Caractéristiques :

Code	LT-004219	
Dimension	1212*57*76mm	
Puissance	36W	
Température de couleur	2700K- 4000K	
Alimentation	AC 220-240V	
LED Driver	intégré	
Dimmable	En option	
Flux lumineux en 4000K	3600 lm	
Rendement lumineux	100lm/W	
Finition du produit	Blanc RAL 9016	
Angle de faisceau	65°	
Couleur	Noire / blanc	
Durée de vie	50000 hrs	
Matériel d'optique	Polycarbonates	
Indice de protection	IP20	
IRC	80	
Durée de vie	50000 Hrs	
Classe électrique	I	
Installation	Montage suspendu	
Accessoire (s)	LT-004219- Kits-Susp-1	LT-004219- Kits-Susp-2
	Accessoires de suspensions du longueur 1500mm	Installation suspendue avec câble de verrière et plafonnier round du longueur 1m
Certificats	CE et Cmim	
Garantie	5ans	



LUMTECH

Réglable linéaire 36W LED-IP20



Procédure d'installation :

spec	A ± 10
1212mm	1185mm
1512mm	1485mm
1812mm	1785mm
2412mm	2385mm

Standard

L = Switched
 ⊕ = Earth
 N = Neutral

Wire diameter: 0.5-2.5mm²
 Wire stripping length: 8-10mm

select preferred colour temperature for product in CCT change function only

COMPLETE



LUMTECH

Réglable linéaire 36W LED-IP20



Procédure d'installation :

spec	A ± 10	B ± 10
1212mm	1185mm	-
1512mm	1485mm	-
1812mm	1785mm	-
2412mm	2385mm	1185mm

Standard	DALI/0-10V
<p>L = Switched ⊕ = Earth N = Neutral</p>	<p>DA/V+ = DIM+ DA/V- = DIM- L = Switched ⊕ = Earth N = Neutral</p>

<p>L — Switched ⊕ — Earth N — Neutral</p>	<p>Wire diameter: 0.5-2.5mm² Wire stripping length: 8-10mm</p>
---	--

select preferred colour temperature for product in CCT change function only

COMPLETE