

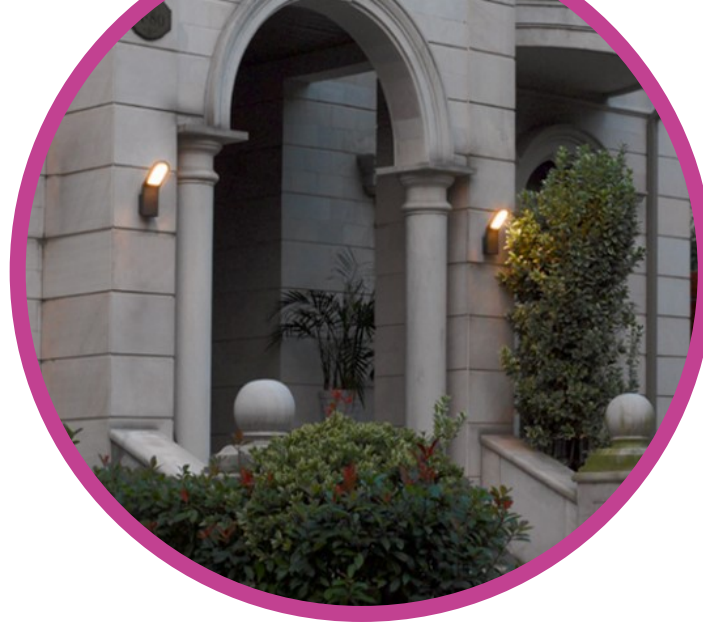

LUMTECH

Applique avec détecteur de mouvement 9W IP54



LT-002781



Sensor

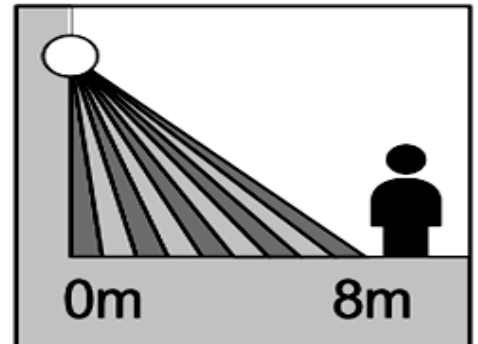
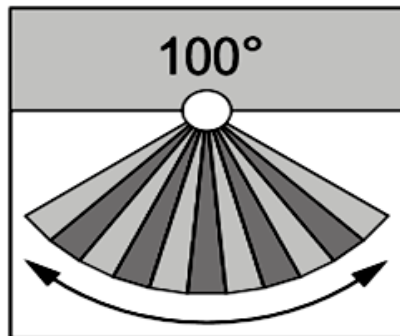
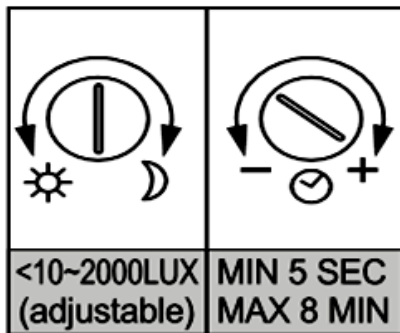

Données photométriques (3000K, 40°):

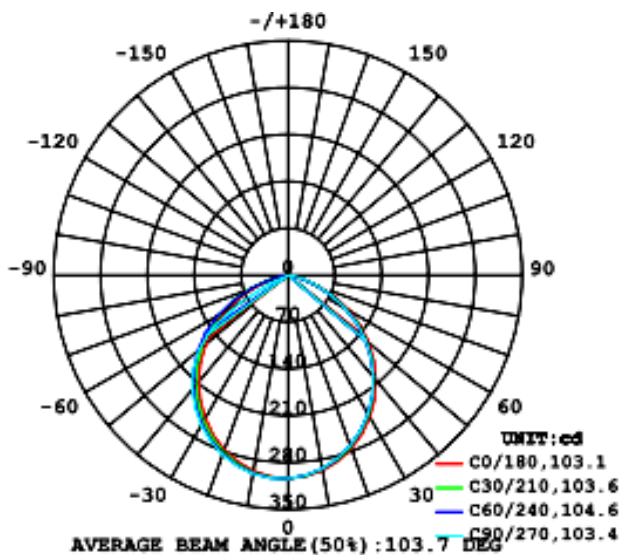

Courbe de distribution de la lumière [Unit : cd]

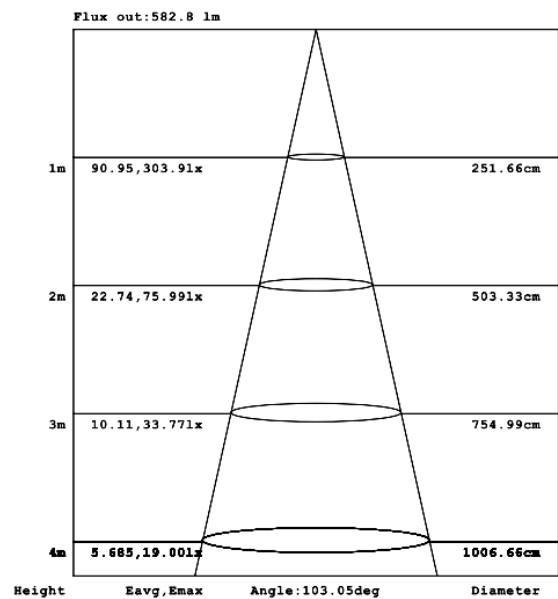

Courbe de Lux distance



LUMTECH

Applique avec détecteur de mouvement 9W IP54



Dimensions :

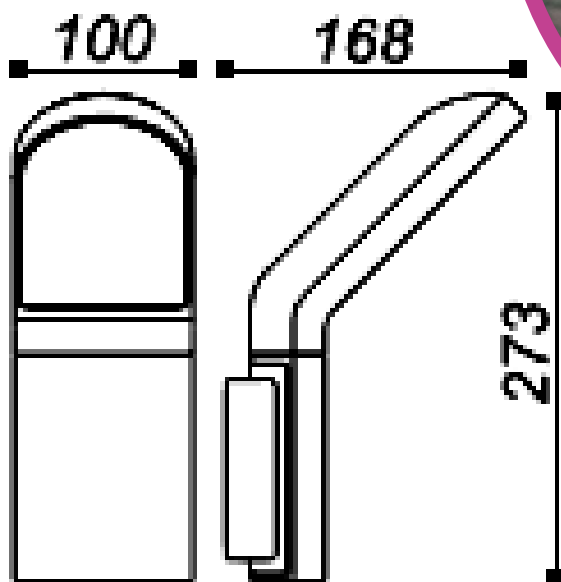

Caractéristiques :

Code	LT-002781
Dimensions	100 x 168 x 273 mm
Réservation	-
Puissance	9W
Température de couleur	3000K / 4000K / 6000K
Alimentation	AC 220-240V
Type de LED	2835 EVERLIGHT
Quantité de LED	9 unités
Flux lumineux en 3000K	666 lm
Type de lentille	-
Marque de driver	-
Dimmable	Non
Angle de faisceau	103°
Couleur	Noir
Matériaux	Aluminium + verre
Longueur de câble	-
Facteur de puissance	≥0.7
Indice de protection	IP54, IK06
IRC	>80
UGR	≥19.4
Durée de vie	30 000h
Température de fonctionnement	-20°C - +50°C
Classe électrique	I
Courant d'appel	≤20A
Accessoire(s)	-
Certificats	CE, Cmim
Garantie	2 ans