

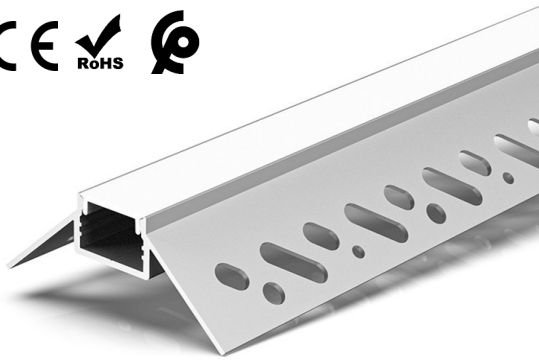

LUMTECH

Profilé d'angle aluminium encastré



LT-CT7

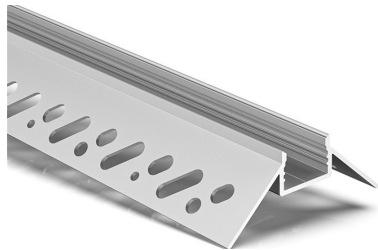

Accessoires :



LT-CT7-EXT

LT-CT7-EXT

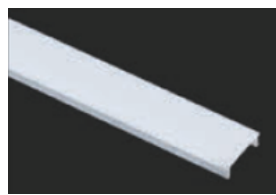

LT-CT7-DIFF

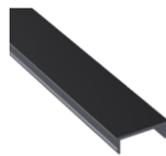

Nouveauté : le diffuseur noir pour une intégration parfaite du profilé sur les surfaces sombres.



LUMTECH

Profilé d'angle aluminium encastré



Dimensions :

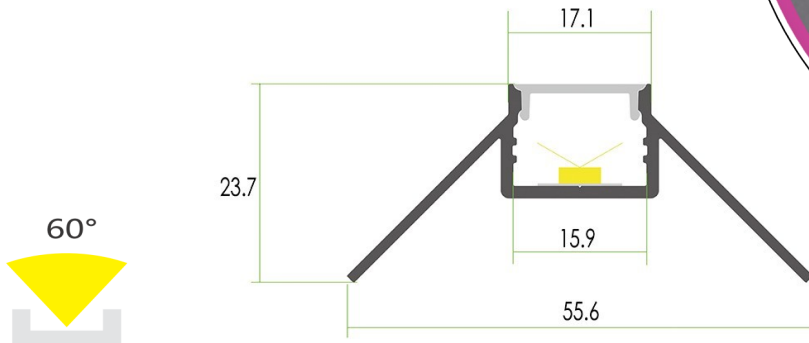

Caractéristiques :

Code	LT-CT7				
Dimensions	55.6mm x 23.7mm				
Réservation	-				
Largeur max du ruban	16mm				
Longueur	2m				
Matériaux	Aluminium				
Angle	60°				
Type de Diffuseur PMMA	LT-CT7-DIFF-B	LT-CT7-DIFF-O	LT-CT7-DIFF-L	LT-CT7-DIFF-F	LT-CT7-DIFF-C
	Noir	Opale	Laiteux	Grivré	Transparent
Transmission de lumière	22%	52%	—	—	—
Accessoires	LT-CT7-EXT		LT-CT7-EXTT		
	Bouchon d'extrémité sans trou		Bouchon d'extrémité avec trou		
Certificats	CE - RoHS - Cmim				
Garantie	2 ans				

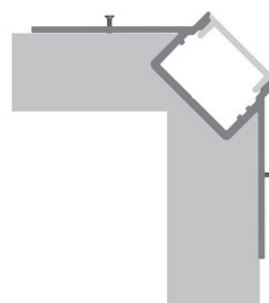
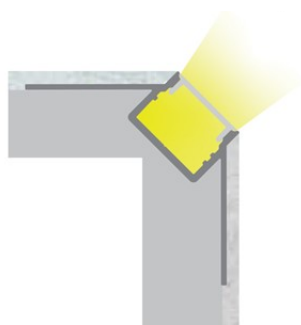



LUMTECH

Profilé d'angle aluminium encastré



Installation :

Diffuseur

