



LUMTECH

Profilé aluminium encastré



LT-AT5

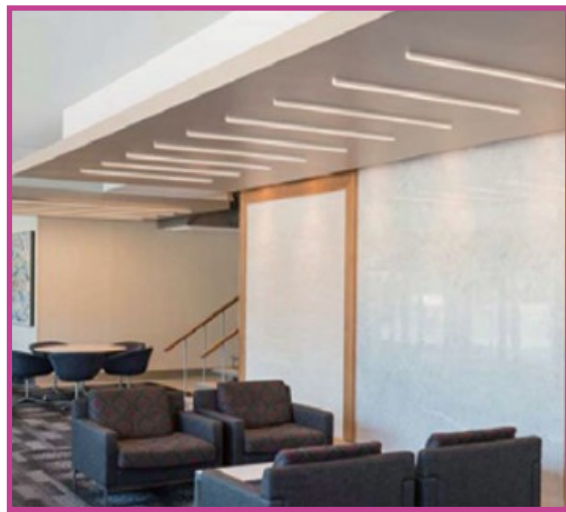

Accessoires :

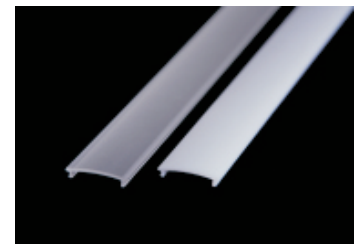

LT-AT5-DIFF

Bouchons d'extrémité



LT-AT5-EXT

LT-AT5-EXTT

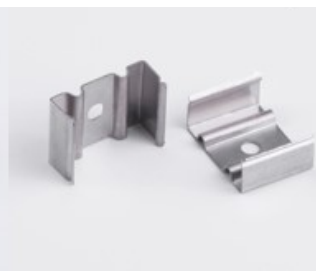

LT-AT5-CLIP-M



LT-AT5-CLIP-A



LT-AT5-KIT

Clips



LUMTECH

Profilé aluminium encastré



Dimensions :

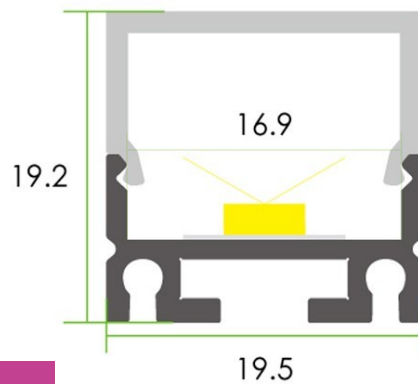

Caractéristiques :

Code	LT-AT5				
Dimensions	19.5mm x 19.2mm				
Réservation	-				
Largeur max du ruban	16.9mm				
Longueur	2m				
Matériaux	Aluminium				
Angle	120°				
Type de Diffuseur PMMA	LT-AT5-DIFF-B	LT-AT5-DIFF-O	LT-AT5-DIFF-L	LT-AT5-DIFF-F	LT-AT5-DIFF-C
	Noir	Opale	Laiteux	Grivré	Transparent
Transmission de lumière	—	51%	—	65%	73%
Accessoires	LT-AT5-CLIP-M	LT-AT5-CLIP-P	LT-AT5-CLIP-A	LT-AT5-EXT	LT-AT5-EXT
	Clip en métal	Clip en plastique	Clip ajustable (0-222°)	Bouchons d'extrémité avec trou	Bouchons d'extrémité sans trou
Certificats	CE - RoHS - Cmim				
Garantie	2 ans				

Installation :

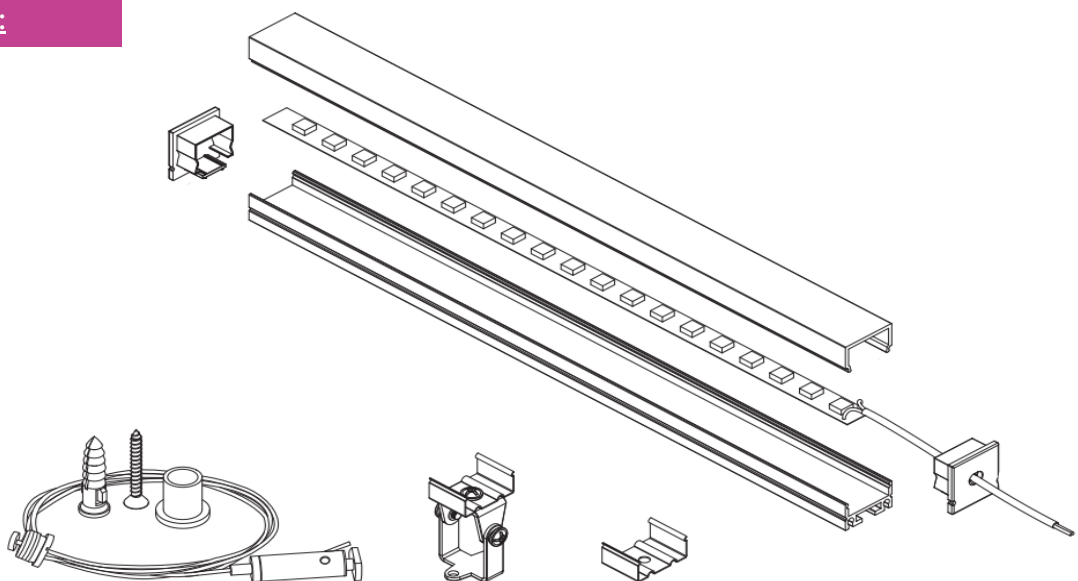



LUMTECH

Profilé aluminium encastré

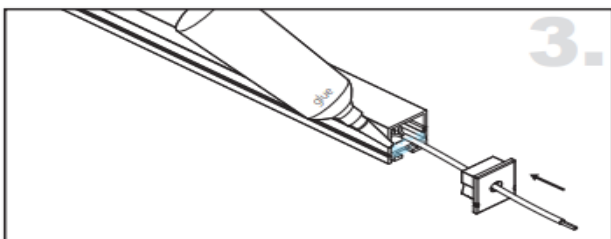
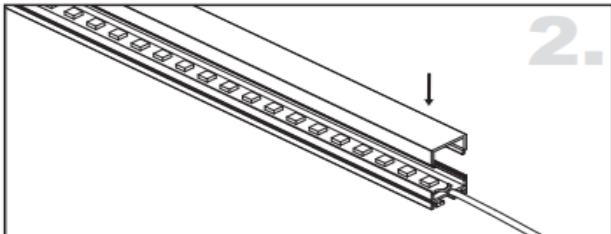
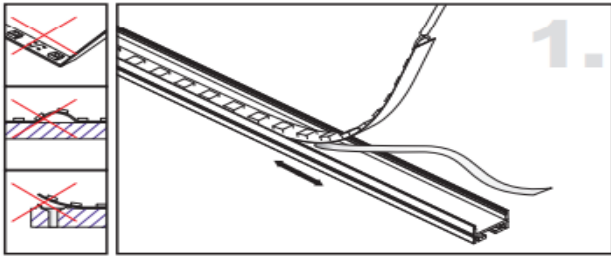

Installation avec clip métallique

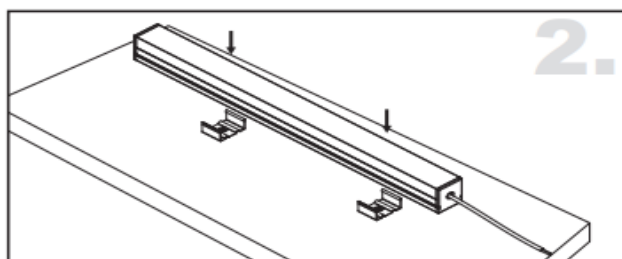
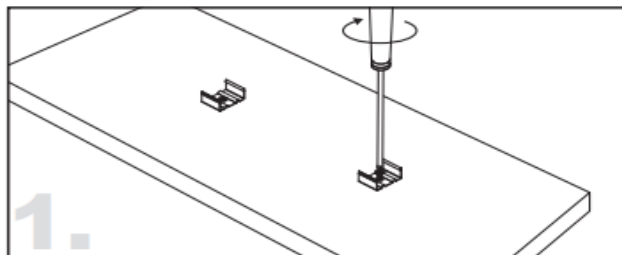

Installation avec clip ajustable

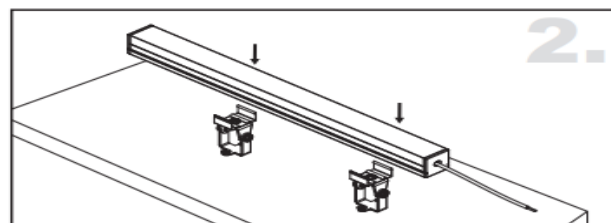
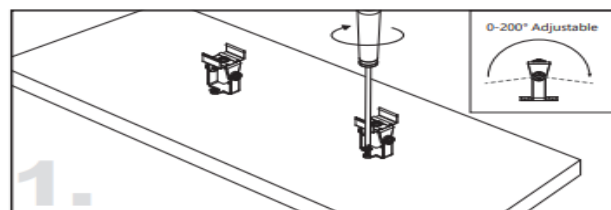

Installation avec kit de suspension

