



Profilé aluminium suspendu



LT-AT15-30



Accessoires :

Bouchons d'extrémité



LT-AT15-30-EXT

LT-AT15-30-EXTT

Clips



LT-AT15-30-kit



90°A



90°B



180°



120°



Profilé aluminium suspendu



Dimensions :

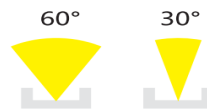
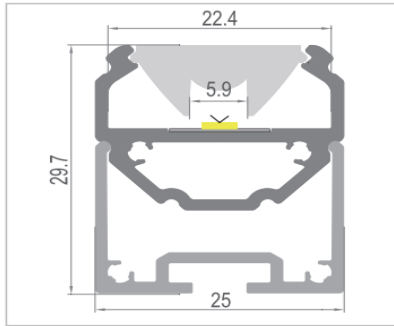

Caractéristiques :

Code	LT-AT15-30				
Dimensions	25mm x 29.7mm				
Réservation	-				
Largeur max du ruban	10mm				
Longueur	2m				
Matériaux	Aluminium				
Angle	30°				
Type de Diffuseur PMMA	LT-AT15-30-B	LT-AT15-30-O	LT-AT15-30-L	LT-AT15-30-F	LT-AT15-30-C
	Noir	Opale	Laiteux	Givré	Transparent
Transmission de lumière	—	70%	78%	—	—
Accessoires	LT-AT15-30-KIT		LT-AT15-30-EXTT	LT-AT15-30-EXT	
	Kits suspension		Bouchons d'extrémité avec trou	Bouchons d'extrémité sans trou	
Certificats	CE - RoHS - Cnim				
Garantie	2 ans				





Profilé aluminium suspendu



Installation :

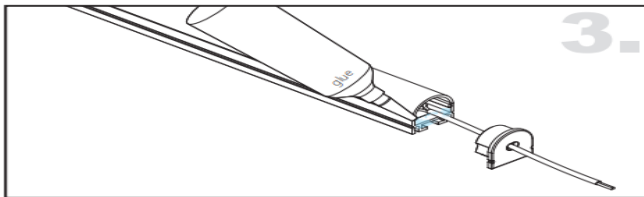
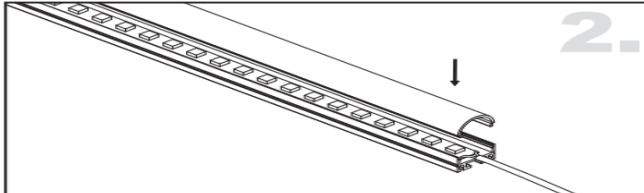
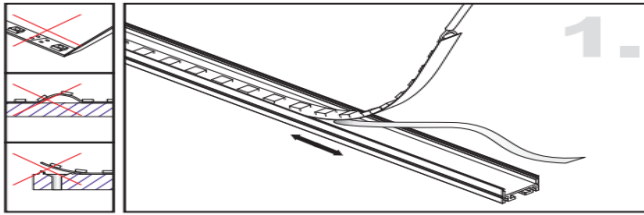

Installation avec clip métallique

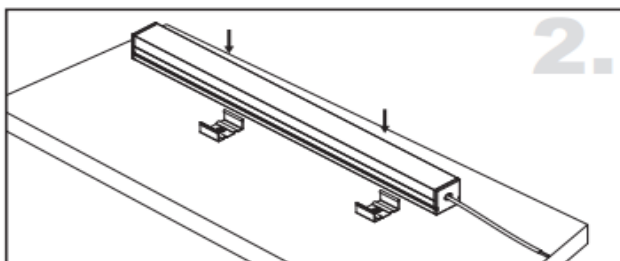
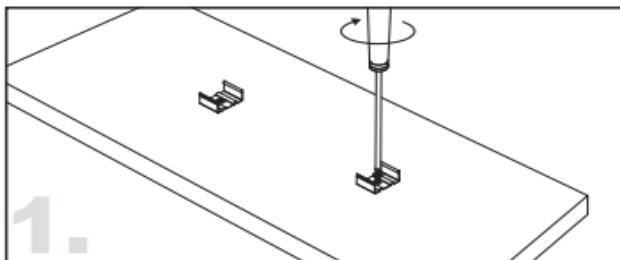

Installation avec clip ajustable

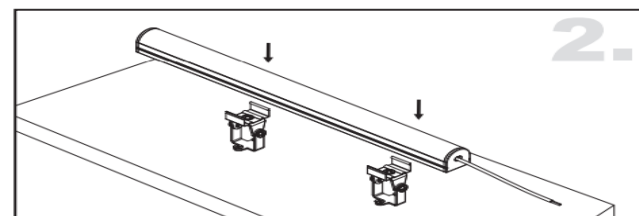
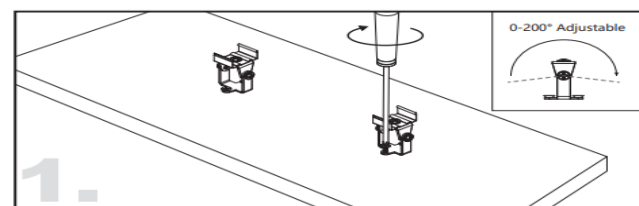

Installation avec kit de suspension

