



# LUMTECH

Spot en surface 8w IP67



LT-003724-B



Données photométriques (3000K;25°)

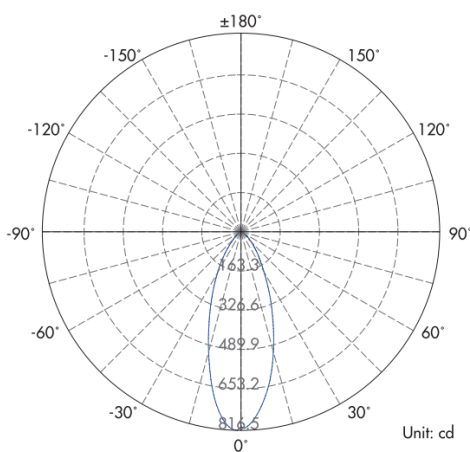

Courbe de distribution de la lumière [Unit : cd]

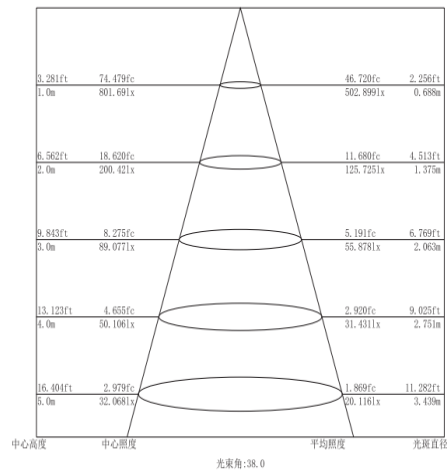

Courbe de Lux distance (3000k,25°)

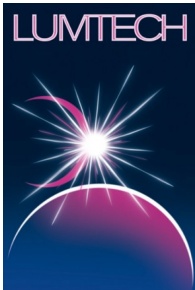

# LUMTECH

## Spot en surface 8w IP67



### Dimensions :

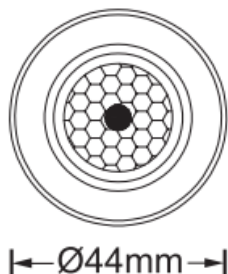

← Ø44mm →

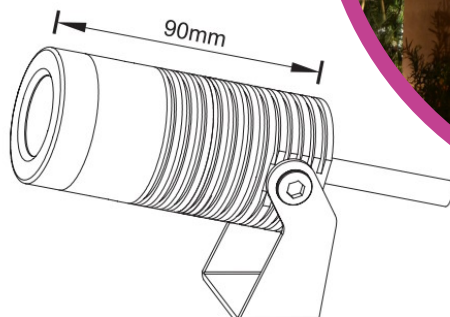

### Caractéristiques :

Code	LT-003724-B
Dimensions	Ø44mm x H90mm
Réservation	-
Puissance	8W
Température de couleur	2700K / 3000K / 4000K / 6000K
Alimentation	AC 95-265V
Courant d'appel / rush current	-
Type de LED	1 PC 8W CREE COB LED
Quantité de LED	1
Flux lumineux en 3000K et 25°	560~640 lm
Type de lentille	-
Marque de driver	-
Angle du faisceau	60°, 36°
Couleur	Noir
Matériaux	Aluminium +verre trempé
Longueur de câble	1m du câble H05RNF-F 3x1mm
Facteur de puissance	-
Indice de Protection	IP67 , IK04
CRI	>90
Durée de vie	50 000h (L890B10@25°C)
Température de fonctionnement	de -20°C à +50°C
Classe électrique	I
Certificats	CE - CMIM
Garantie	3 ans

	LT-003724-SHIELD-48	LT-003684-SPIKE	LT-003684-BASE	LT-003684-BELT-2M
Accessoires complémentaires	Casquette en aluminium noir	Piquet en plastique ABS 39x170mm	patère ronde en aluminium Ø75mm	Sangle en Nylon noir avec attaches en inox 304

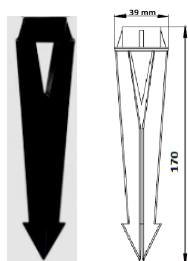

LT2-003684-SPIKE

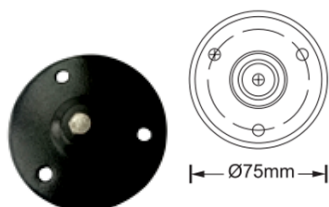

LT2-003684-BASE



LT2-003724-SHIELD-48



LT2-003684-BELT-2M